

## ASSEMBLY INSTRUCTIONS

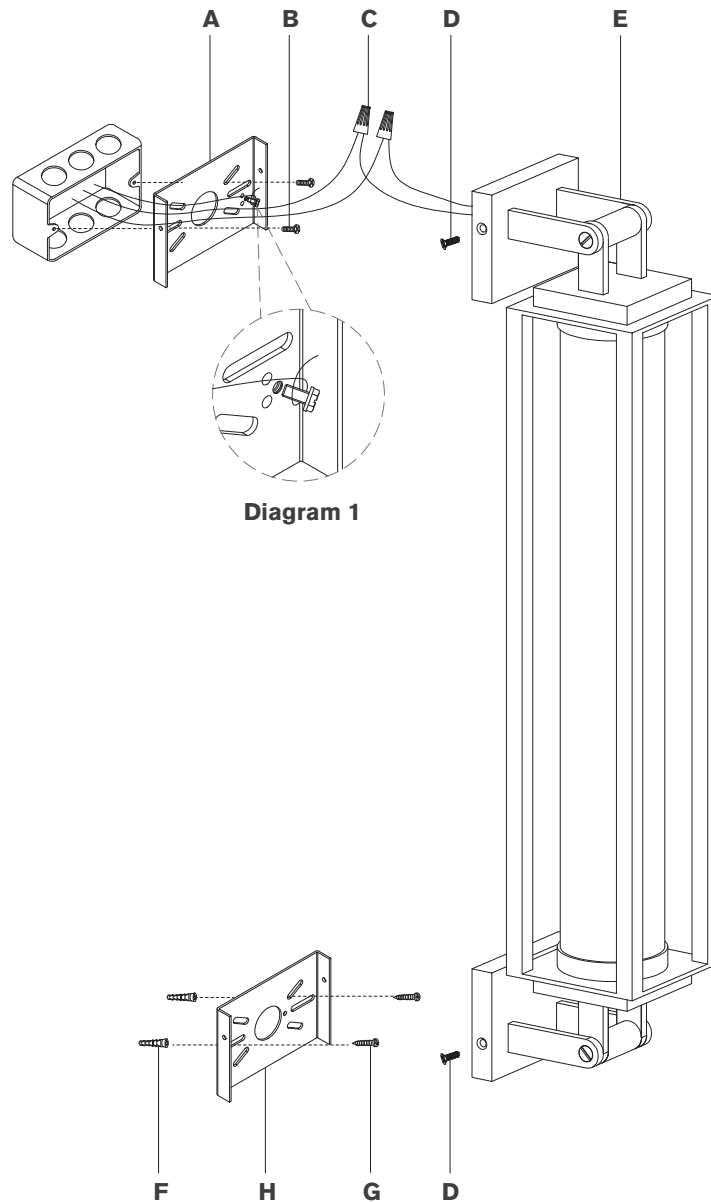

## Northport 24" Linear Sconce

Item # RL2565

### NOTICE:

This light fixture should be installed in accordance with all applicable, local installation codes, and by a person familiar with the construction and operation of it, as well as the hazards involved. Inspect item and contents carefully. If any damage or defect is found, do not install. Retain all packaging material until installation is complete and approved.

### TOOLS REQUIRED (NOT INCLUDED):

Phillips Screwdriver      Slotted Screwdriver      Drill  
Pencil      Hammer

1. Carefully remove all parts from the box. Place on a clean, soft surface.
2. Remove mounting plate **(A & H)** from fixture **(E)** by removing screws **(D)**.
3. Install mounting plate **(A)** to junction box and secure with mounting screws **(B)**.
4. Using mounting plate **(H)** and fixture body as a guide, mark anchor positions.  
**NOTE:** Carefully measure distance between mounting points for mounting plate **(H)** and junction box before moving to the next step.
5. Using a drill bit slightly smaller than the anchor, drill holes in the marked positions. Install anchors **(F)** into the holes using hammer.
6. Install mounting plate **(H)** to wall and secure with wood screws **(G)** to anchors **(F)**.
7. Wrap supply ground wire (bare copper) around the green grounding screw. Tighten. (See diagram 1)
8. Connect fixture neutral wire (white) to the supply neutral wire (usually white) using wire nut **(C)**.
9. Connect fixture hot wire (black) to the supply hot wire (usually black) using wire nut **(C)**.

**CAUTION:** Do not reverse the hot and neutral connections.

# RALPH LAUREN



## ASSEMBLY INSTRUCTIONS

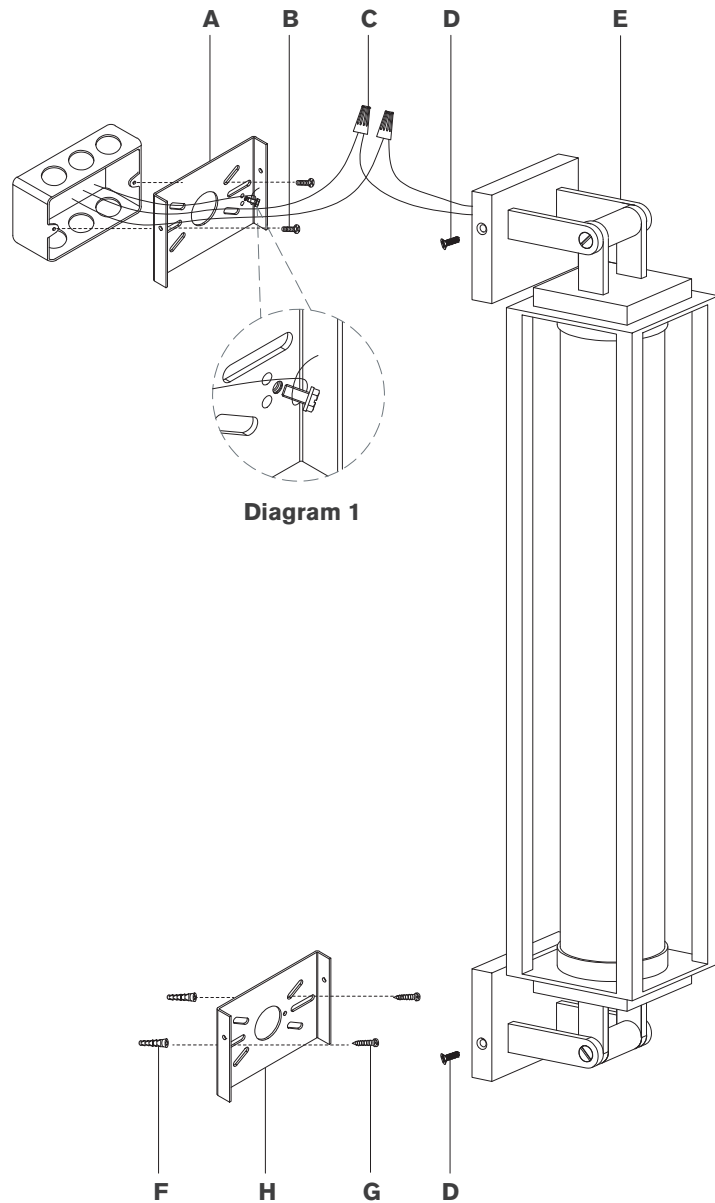

## Northport 24" Linear Sconce

Item # RL2565

### NOTICE:

This light fixture should be installed in accordance with all applicable, local installation codes, and by a person familiar with the construction and operation of it, as well as the hazards involved. Inspect item and contents carefully. If any damage or defect is found, do not install. Retain all packaging material until installation is complete and approved.

10. Make sure all wire connections are tight, then carefully tuck into the junction box.
11. Install fixture (E) to mounting plates (A & H) by securing with screws (D).

### FOR OUTDOOR/WET LOCATION INSTALLATION:

12. Using silicon compound, apply a small bead where backplate meets the wall to prevent water from entering.

**NOTE:** Large gaps will need to be corrected before applying silicon compound.

**Care Instructions:** Clean only with a soft dry cloth or feather duster. Do not use abrasive or chemical agents.

# RALPH LAUREN

